



NORTHSTONE

A CRH COMPANY

ROOF TILES AND ACCESSORIES





QUALITY YOU CAN TRUST

NORTHSTONE (NI) LTD ARE PART OF CRH PLC A WORLDWIDE MANUFACTURER AND SUPPLIER OF BUILDING MATERIALS.

The Northstone roof tile brand offers a unique range of roof tiles designed to compliment the roof covering of all types of buildings, from the one off self build project through to the largest housing development, schools, or commercial property.

Northstone have been manufacturing quality roof tiles since 1964, and their experienced staff ensure their enviable reputation for quality and reliability is consistently achieved. All roof tiles are manufactured to the latest European standard BS EN 490 within a recognised management system BS EN ISO 900. A full range of roofing accessories is available to match the four tile profiles including a comprehensive range of dry fix ridging and dry fix verge solutions.

A FULLY TRAINED AND EXPERIENCED TEAM OF TECHNICAL REPRESENTATIVES ARE ON HAND TO SUPPORT CUSTOMERS with free estimates, technical advice, samples and design assistance including specification detailing. Contact information is on the back page.

Northstone are committed to product development and continuous improvement for its roof tiles and fittings. All information contained in this brochure is accurate at the time of printing.

CAUSEWAY & CAUSEWAY RIVEN

The Causeway roof tile is Northstone's second generation thin leading-edge roof tile. The Causeway offers contractors, specifiers and home builders the beauty of a slate effect roof while keeping costs to a minimum. The Causeway is designed with a hidden interlock and a 17mm softened leading edge to improve its slate aesthetics. The effective cover width has been increased which reduces the number of tiles on a roof by up to 5%. This not only gives economic advantages but presents environmental benefits. A full range of maintenance free dry fix accessories are available and additional fixings have been designed for extremely exposed environments and steep and low pitched roofs. The Causeway is manufactured with through coloured pigment.



Available accessories for these tiles

- ✓ Standard Verge
- ✓ Dry Hip
- ✓ Dry Valley
- ✓ Ornamental Ridge
- ✓ Dry Ridge
- ✓ TLE Dry Verge
- ✓ Finials
- ✓ Vent Tiles

Standard Ridge = Universal Angle



TECHNICAL DATA

Description	T-EN490-IL-0-RF-311-/-/400-4.65
Size of Tile	420 x 334mm
Leading Edge Depth	17mm approximately
Pallet Size	1000 x 1065mm
Pallet Weight	1140kg (approximately)
Tiles per Pallet	240 tiles
Minimum Pitch	17.5° (100mm headlap) 25° (75mm headlap)
Maximum Pitch	54° (without special fixings)
Minimum Headlap	75mm
Maximum Gauge	345mm
Hanging Length	400mm
Normal Cover Width	311mm (approximately)
Tile Weight	4.65kg (approximately)
Nail Hole Diameter	5-8mm
Nail Hole Position	38mm from top of tile
Covering Capacity per m²	9.45 tiles at 75mm headlap 10.2 tiles at 100mm headlap
Weight of Tiling per m²	44kg/m ² at 75mm headlap (approximately) 47.5Kg/m ² at 100mm headlap (approximately)
Battens Required per m²	2.95m at 75mm headlap 3.1m at 100mm headlap
Batten Size	50mm x 25mm for rafters not exceeding 600mm centres
Tile Nails	45mm x 3.35mm ring shanked aluminium clout nail
Tile Clips	Tile, Verge and Eave clips
Eave Tiles	Standard tile single lap
Verge Dry Fix	Northstone Dry Verge System (mechanically fixed)
Ridge Dry Fix / EasyFix	Universal Angle Ridge 450mm long fixed with Northstone Dry Ridge system
Hip Dry Fix	Universal Hip Angle Ridge 450mm long fixed with Northstone Dry Hip System

Minimum Fixing Guide: All tiles should be fitted to BS5534 : 2014 where a minimum requirement specifies a minimum of all tiles nailed once on the right hand nail hole. Depending on site exposure, location, height to ridge, height to eave, rafter length, roof pitch and proximity of roof to higher artificial features and aviation activity more onerous fixings may be required. Contact our technical team for advice or a wind loading fixing pattern.



Matt Black



Granite Grey



Basalt Grey



Turf Brown



Brick Red



Antique Red

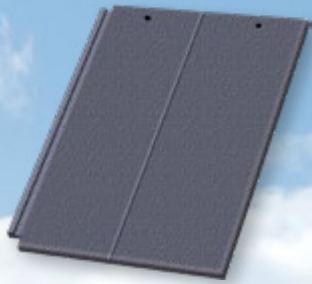

DUNLUCE

The Dunluce roof tile is a variation of the Causeway thin leading edge tile with the impression of a line down the middle making it what is known as a mock bond tile. When laid on a roof the mock bond impression gives the Dunluce the appearance of a smaller European plain tile when fitted on a roof. The headlap can be increased to 225mm to further enhance its small tile appearance but with considerable savings. A full range of maintenance free dry fix accessories is available and additional fixings have been designed for extremely exposed environments and steep and low pitched roofs. The Dunluce is manufactured with through coloured pigment.

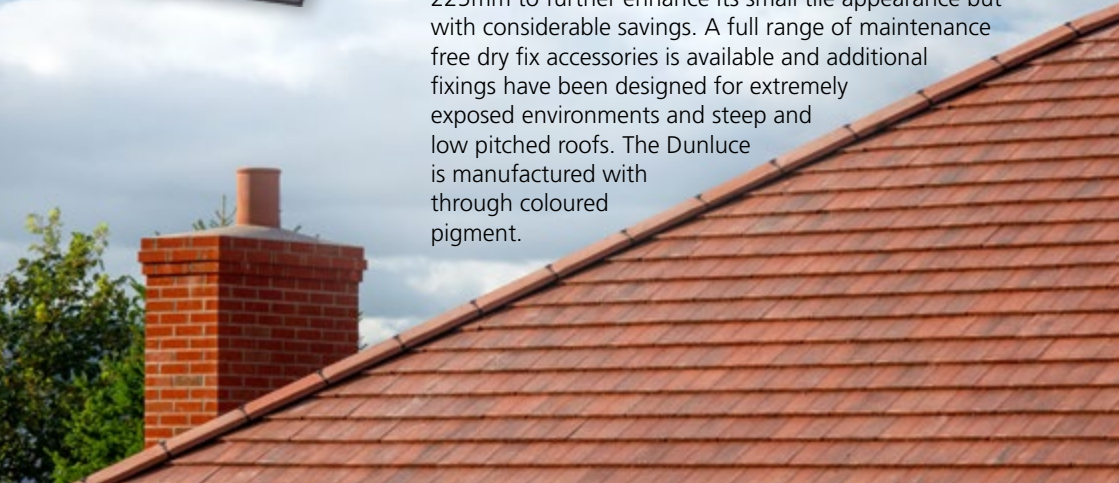

Available accessories for these tiles

- ✓ Standard Verge
- ✓ Dry Hip
- ✓ Finials
- ✓ Ornamental Ridge
- ✓ Dry Ridge
- ✓ TLE Dry Verge
- ✓ Dry Valley
- ✓ Vent Tiles

Standard Ridge = Universal Angle

TECHNICAL DATA

Description	T-EN490-IL-0-RF-311-/-400-4.65
Size of Tile	420 x 334mm
Leading Edge Depth	17mm approximately
Pallet Size	1000 x 1065mm
Pallet Weight	1140kg (approximately)
Tiles per Pallet	240 tiles
Minimum Pitch	17.5° (100mm headlap) see fixing guide page 12 25° (75mm headlap)
Maximum Pitch	54° (without special fixings)
Minimum Headlap	75mm
Maximum Gauge	345mm
Hanging Length	400mm
Nominal Cover Width	311mm (approximately)
Tile Weight	4.65kg (approximately)
Nail Hole Diameter	5-8mm
Nail Hole position	38mm from top of tile
Weight of Tiling	44kg/ m2 at 75mm headlap (approximately) 47.5kg/ m2 at 100mm headlap (approximately)
Covering Capacity per m²	9.45 tiles @ 75mm headlap 10.2 tiles @ 100mm headlap
Battens required per m²	2.95m at 75mm headlap 3.1m at 100mm headlap
Batten Size	50mm x 25mm for rafters not exceeding 600mm centres
Tile Nails	45mm x 3.35mm ring shanked aluminium clout nail
Tile Clips	Tile, Verge and Eave clips
Eave Tiles	Standard tile single lap
Verge Dry Fix	Northstone TLE Dry Verge System
Ridge Dry Fix	Universal Angle Ridge 455mm long fixed with Northstone Dry Ridge system
Hip Dry Fix	Universal Hip Angle Ridge 455mm long fixed with Northstone Dry Hip System

Minimum Fixing Guide: All tiles should be fitted to BS5534 : 2014 where a minimum requirement specifies a minimum of all tiles nailed once. Depending on site exposure, location, height to ridge, height to eave rafter length roof pitch and proximity of roof to higher artificial features and aviation activity more onerous fixings may be required. Contact our technical team for advice or a wind loading fixing pattern.



Matt Black



Granite Grey



Basalt Grey



Turf Brown



Brick Red



Antique Red

DONARD & PENROSE



The Donard and Penrose are traditional flat tiles offering the clean lines and smart finish of an interlocking slate pattern. These tiles have an approximately 26mm leading edge and have been tried and tested over many years to withstand the most extreme weather conditions throughout the UK and Ireland. A full range of maintenance free dry fix accessories is available and additional fixings have been designed for extremely exposed environments and steep and low pitched roofs.



Available accessories for these tiles

- ✓ Standard Verge
- ✓ Dry Hip
- ✓ Finials
- ✓ Ornamental Ridge
- ✓ Dry Ridge
- ✓ Dry Verge
- ✓ Dry Valley
- ✓ Vent Tiles

Standard Ridge = Universal Angle

TECHNICAL DATA

Description	T-EN490-IL-0-RF-297-/-/-399-5.2
Size of Tile	419mm x 330mm
Pallet Size	1000 x 1065mm
Pallet Weight	1023kg (approximately)
Tiles per Pallet	192 tiles
Minimum Pitch	17.5° (100mm headlap) 22.5° (75mm headlap)
Maximum Pitch	54° (without special fixing) see fixing information, page 23
Minimum Headlap	75mm
Maximum Gauge	344mm
Hanging Length	399mm
Nominal Cover Width	297mm
Tile Weight	5.2kg
Nail Hole Diameter	5-8mm
Nail Hole position	40mm from top of tile
Covering Capacity per m2	9.8 tiles @ 75mm headlap
Weight of Tiling (approx.)	51kg/m2 @ 75mm headlap
Battens Required (net)	2.95Lm @ 75mm headlap
Batten Size	50mm x 25mm for rafters not exceeding 600mm centres
Tile Nails	50mm x 3.35mm
Tile Clips	Tile, Verge and Eave
Eave	Standard Tile
Verge Bedded	Purpose made Left and Right Hand Half Tiles, and Left Hand Full tiles, bedded over a soffit strip
Verge Dry Fix	Roo Verge Dry Verge System
Ridge Bedded	Universal Angle Ridge 0.455m long
Ridge Dry Fix	Roovent Dry Ridge System
Hip Bedded	Hip Angle Ridge 0.455m long
Hip Dry Fix	Roo Ridge Dry Hip System



Matt Black



Granite Grey



Basalt Grey



Turf Brown



Brick Red



Antique Red

Minimum Fixing Guide: All tiles should be fitted to BS5534 : 2014 where a minimum requirement specifies a minimum of all tiles nailed once. Depending on site exposure, location, height to ridge, height to eave rafter length roof pitch and proximity of roof to higher artificial features and aviation activity more onerous fixings may be required. Contact our technical team for advice or a wind loading fixing pattern.

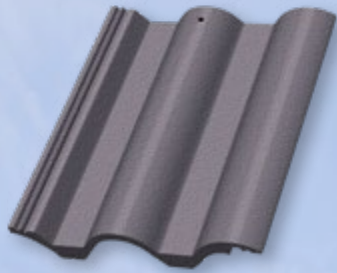

DERRIE

The Derrie tile has a traditional double roll pattern which has a proven performance for over forty years. The double roll gives the tile an inherent strength and far exceeds any strength tests specified by the British and European standards for roof tiles. The raised interlock and wide anti capillary bars improves the products performance at lower pitches. The Derrie also performs well in areas of high winds. A full range of maintenance free dry fix accessories is available and additional fixings have been designed for extremely exposed environments and steep and low pitched roofs. The Derrie is manufactured with through coloured pigment.

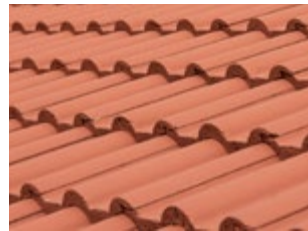

Available accessories for these tiles

- ✓ Standard Verge
- ✓ Dry Hip
- ✓ Dry Valley
- ✓ Ornamental Ridge
- ✓ Dry Ridge
- ✓ Dry Verge
- ✓ Finials
- ✓ Vent Tiles

Standard Ridge = Universal Angle

TECHNICAL DATA

Description	T-EN490-IL-0-RF-297-/-/-399-5.2
Size of Tile	419mm x 330mm
Pallet Size	1000 x 10656mm
Pallet Weight	1013kg (approximately)
Tiles per Pallet	192 tiles
Minimum Pitch	17.5° (100mm headlap) 22.5° (75mm headlap)
Maximum Pitch	54° (without special fixing) see fixing information, page 23
Minimum Headlap	75mm
Maximum Gauge	344mm
Hanging Length	405mm
Nominal Cover Width	300mm
Tile Weight	5.15kg
Nail Hole Diameter	5-8mm
Nail Hole position	33mm from top of tile
Covering Capacity per m²	9.7 tiles @ 75mm headlap
Weight of Tiling (approx.)	50kg/m ² @ 75mm headlap
Battens Required per m²	2.95Lm @ 75mm headlap 3.1Lm @ 100mm headlap
Batten Size	50mm x 25mm for rafters not exceeding 600mm
Tile Nails	70mm x 3.35mm
Tile Clips	Tile, Verge and Eave
Eave	Standard Tile
Verge Bedded	Purpose made Left Hand Full tiles, bedded over a soffit strip
Verge Dry Fix	Northstone Dry Verge System
Ridge Bedded	Universal Angle Ridge 0.455m long
Ridge Dry Fix	Roovent Dry Ridge System
Hip Bedded	Hip Angle Ridge 0.455m long
Hip Dry Fix	Ro Ridge Dry Hip System



Matt Black



Granite Grey



Basalt Grey



Turf Brown

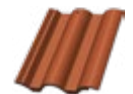

Brick Red



Antique Red

Minimum Fixing Guide: All tiles should be fitted to BS5534 : 2014 where a minimum requirement specifies a minimum of all tiles nailed once. Depending on site exposure, location, height to ridge, height to eave rafter length roof pitch and proximity of roof to higher artificial features and aviation activity more onerous fixings may be required. Contact our technical team for advice or a wind loading fixing pattern.

RIDGE TILES

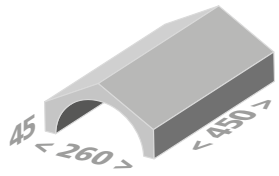

Universal Angle Ridge

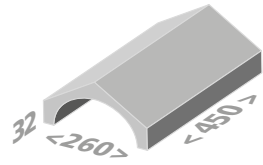

Hip Angle Ridge

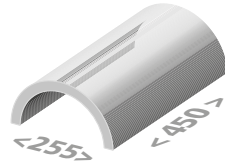

Half Round Ridge

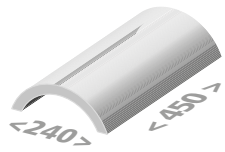

Third Round Ridge

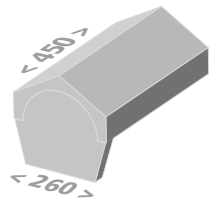

Block End Angle Ridge

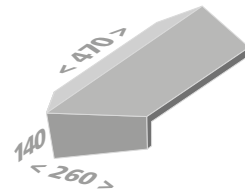

Block End Hip Angle Ridge

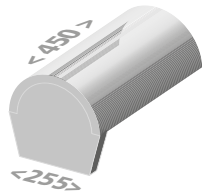

Block End Half Round Ridge

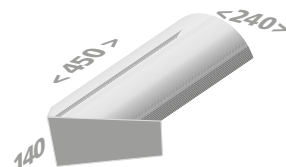

Block End Hip Third Round Ridge

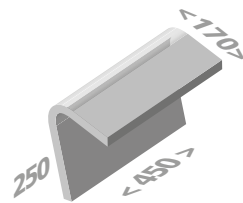

Mono Ridge

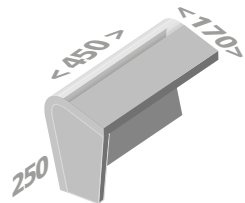

Block End Mono Ridge

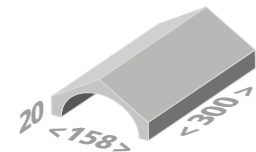

Baby Angle Ridge

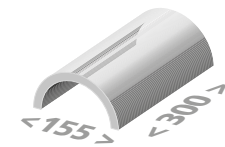

Baby Half Round Ridge

RIDGE TILES

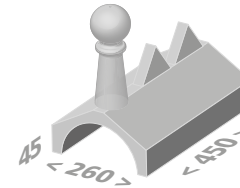

Victoria Tall Ball Finial

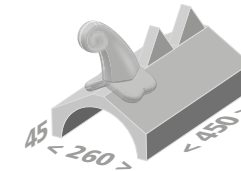

Victoria Scroll Finial

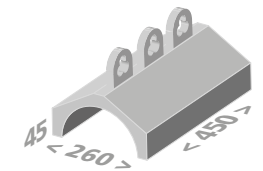

Crown Ridge

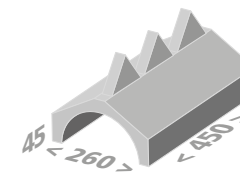

Victoria Ridge



Tall Ball Finial

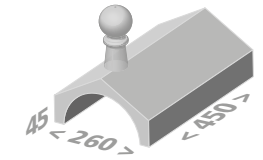

Short Ball Finial



Scroll Finial

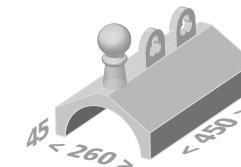

Crown Ball Finial

PLEASE NOTE:
With ornamental ridge tiles allow for a four week lead time from order. All dimensions shown in mm.

The Northstone range of Ridge Tiles are available in the following colours:

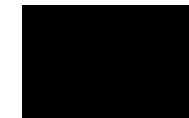

Matt Black



Basalt Grey



Granite Grey



Brick Red



Turf Brown

UNIVERSAL EASY DRY VERGE



Top Four Key Points:

1. UN-handed units - Verge U can be used on both the left and the right verge.
2. Unique design to create a completely sealed verge, preventing water ingress and infestation.
3. Manufactured from Polypropelene for excellent flexibility and UV stability.
4. Complies with BS5534:2014 for verge fixing systems.

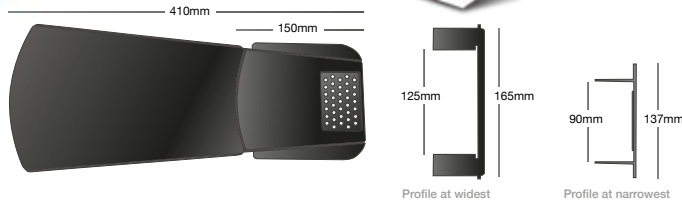

Half Round Ridge Cap

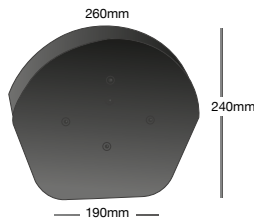

Starter

Angled Ridge Cap

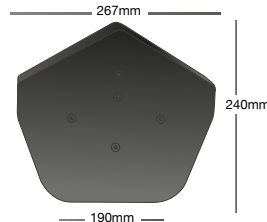

Blanking Plate

DRY RIDGE AND DRY HIP SYSTEM

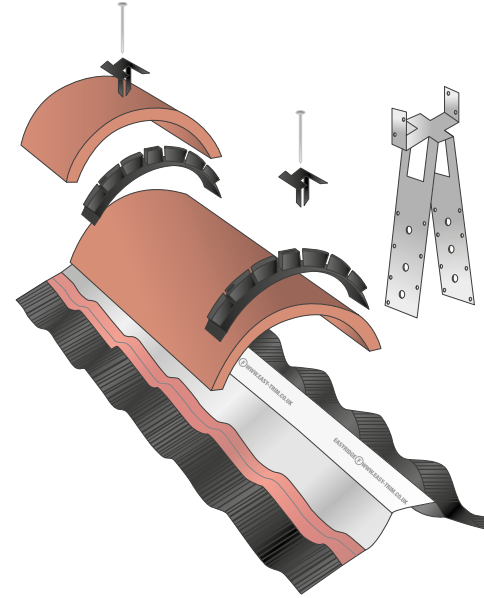

6 Metre Kit contents:

- 1 x 6m Ridge Roll
- 10 x Ridge Batten Brackets
- 13 x Ridge Unions
- 1 x Fixing Kit including:
 - 26 x Outer Clips (standard)
 - 13 x Centre Clips
 - 13 x Screws
 - 45 x Nails (approximately)

Hip Accessory Kit

To be used in conjunction with Ridge F kits, our Hip accessory pack contains all the components required for a hip installation. Short and long leg ratchet clips, cut tile fixings and hip trays sufficient to run along a 6m hip.

Dry Hip Components:

- 6 metre easy Fix Hip Roll
- 10 x Hip Batten Brackets
- 13 x Universal Easyfix Ridge Unions
- 5 x Hip Trays
- 26 x short leg ratchet clips
- 20 x long hip clips
- 20 x short hip clips
- 1 x Fixing Kit

Northstone Ridge Kits

The quality and adaptability of our Dry Fix Ridge Kit and components make it arguably one of the best available on the market. Compliant with BS 5534 requirements for mechanically fixed tiles, the comprehensive Dry Ridge system offers a kit for most tile types.

Ridge Roll

- Allows the roof to breathe whilst repelling water.
- Corrugated aluminium allows a constant 5mm of ventilation
- A pumped butyl self-adhesive strip allows a watertight permanent bond.



FIXING ACCESSORIES

DONARD

DERRIE & SEVILLE

CAUSEWAY & DUNLUCE

NAILS



TILE CLIPS

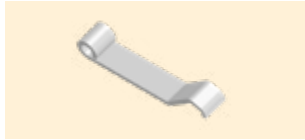

VERGE CLIPS

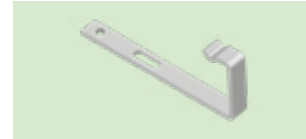
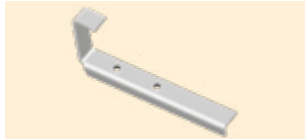

EAVE CLIPS

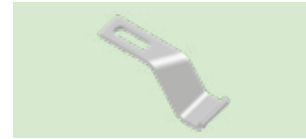

INLINE VENT TILES

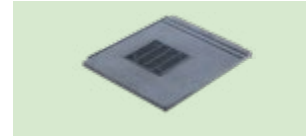
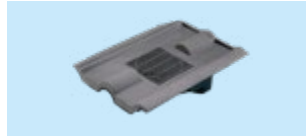
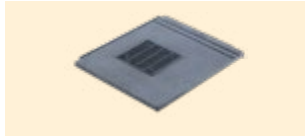

ADAPTERS



FLEXIBLE PIPES

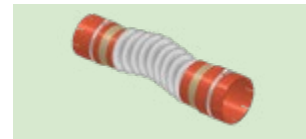
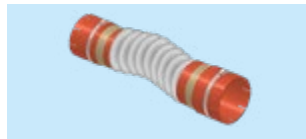
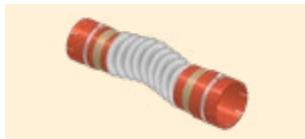

DRY VALLEY

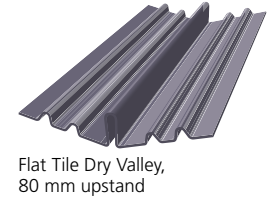
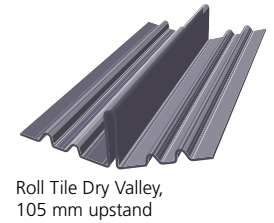
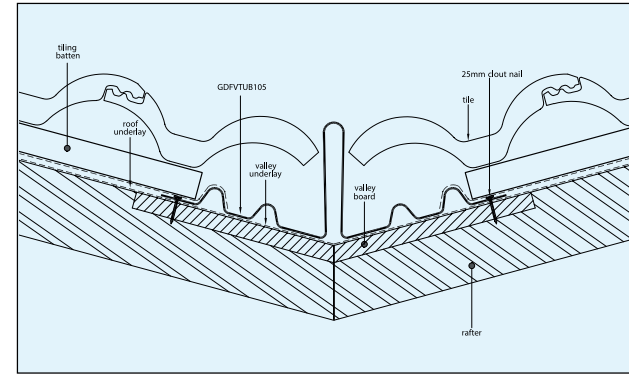

Valley Troughs and Bonding strips are manufactured from lead free grey GRP (Glass Reinforced Polyester) to provide a cost effective alternative to traditional lead roof.

- Life expectancy of over 30 years
- Light and easy to transport, handle and install
- Virtually maintenance free
- BBA Certification (No 07/4492)

BONDING STRIP

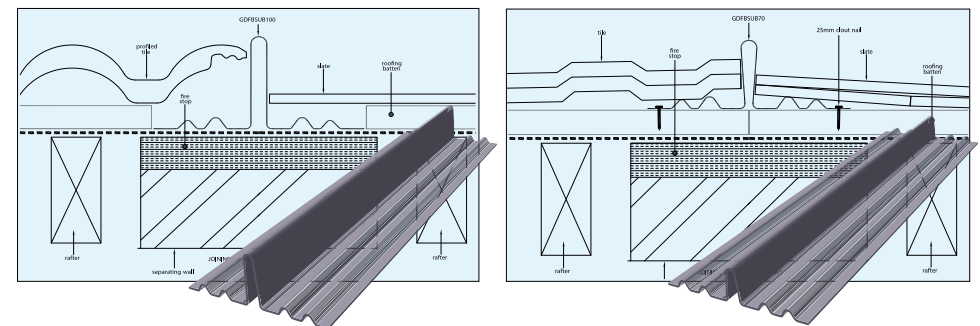

The GRP Bonding Gutter creates a weather-tight joint between dissimilar roof coverings on semidetached and terrace homes whether it be new build or refurbishment

MANUFACTURING & HANDLING



Manufacturing, Handling and Surface Characteristics.

Northstone (NI) Ltd manufacture roof tiles in accordance with the British & European standard BS EN 490 and within an accredited Management system to BS EN 9001.

Whilst every effort is made to produce a consistent product in every aspect we would point out that due to nature of the product, and as a consequence of the manufacturing & handling processes the following surface characteristics may occur. These are fully recognised both within the trade and by BS EN 490.

Scratches & Abrasions: These can be caused by packing, loading, transport and handling on site: These are surface marks only and will disappear with normal weathering conditions.

Efflorescence: This is a naturally occurring phenomenon in concrete products caused by weather conditions penetrating into the pores of the concrete and dissolving lime, the water then evaporates leaving a white film of lime. The same chemical process continues enabling it to be degraded and washed away with

the rain, so that the efflorescence disappears by itself. The level of lime and weather conditions can vary therefore the level of efflorescence can fluctuate also.

Mosses & Lichens: Mosses and lichen tend to grow on roofs which are in the vicinity of trees or in shady, damp conditions. North facing slopes remain damper longer and attract moss and lichen growth more so than roof slopes which dry out quicker.

In normal circumstances these growths are not deleterious to the tile and does not effect the overall performance of the tile.

Surface Coating:

The majority of concrete roof tiles manufactured in the world are surface treated, the major benefit being to protect the tile during the early, critical stages of its lifespan. It is recognised in the roofing industry that the surface coating of a concrete tile is temporary, lasting only for a few years; long enough to give that protection to the early life of the product. The performance of the roof tile is not affected by any of the above conditions and the quality requirements of the tile remain intact.

Fixing Notice

Where the wind load is calculated in accordance with BS 5534: 2014, it provides an uplift force which exceeds the dead load of the tile, mechanical fixings, in addition to the minimum fixings will be necessary. Factors which must be considered:

- Exposure and location of the site
- Roof pitch and rafter Length
- Height of the roof
- Local wind speeds
- Proximity to natural or artificial features affecting wind speeds

The Northstone digital wind loading fixing specification service is available free on request.

Colours

Colours and textures in this brochure are as accurate as can be reproduced by the printing process, however actual samples can be provided before ordering.

Terms and Conditions

Terms and conditions of sale and guarantees for products available in England Scotland and Wales are available on request.



MEET OUR ROOF TILE TEAM



1. KEN ANDERSON NATIONAL SALES MANAGER

(+44) 7803 264 232
kanderson@northstone-ni.com



2. SIMON JAMES AREA SALES MANAGER

(+44) 7385 029 462
sjames@northstone-ni.com



3. PETER MCCARRICK AREA SALES MANAGER

(+44) 7774 811 178
pmccarrick@northstone-ni.com

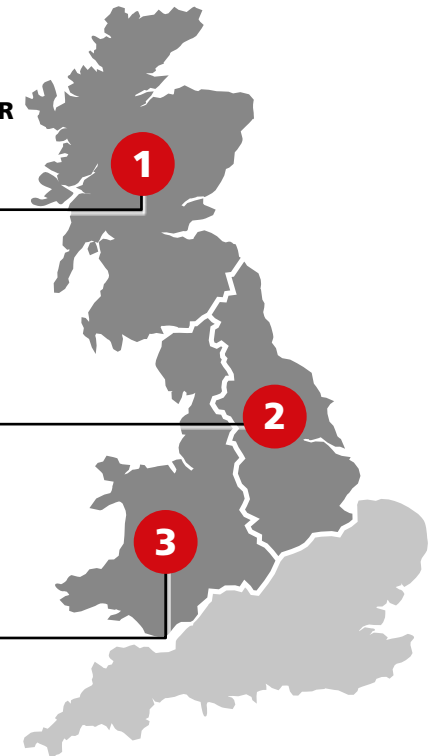

028 7965 1317

www.northstonerooftiles-gb.com

sales@northstone-ni.com

Head Office: 99 Kingsway, Dunmurry, Belfast BT17 9NU

